

NO.	REVISION	DATE

OWNER INFORMATION
 SILVER SPRINGS LLC
 2999 OAK ROAD, SUITE 400
 WALNUT CREEK, CA 94597
 (925) 933-1405



GRADING AND IMPROVEMENT PLANS FOR
PROJECT #66114
GREEN VALLEY ROAD/DEER VALLEY ROAD TURN LANES
 CROSS SECTIONS - GREEN VALLEY ROAD
 TM 97-1330, COUNTY CONTRACT NO. PW 09-30470
 EL DORADO COUNTY CALIFORNIA

TLA
 ENGINEERING & PLANNING

DATE: _____

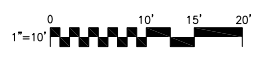
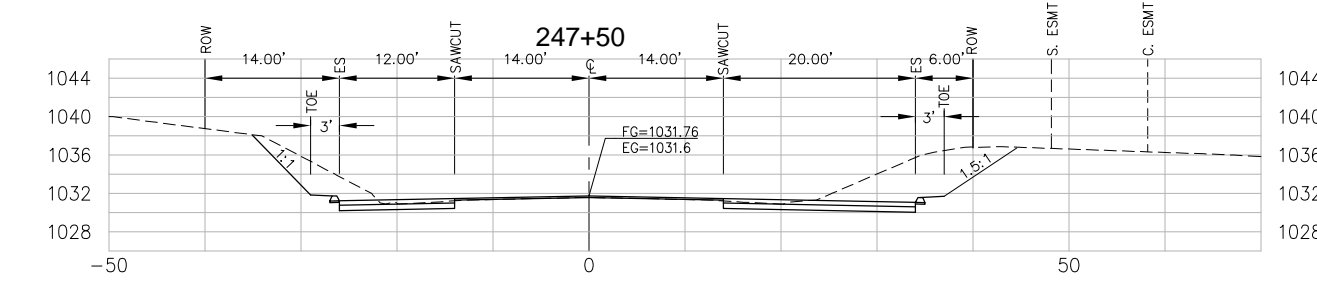
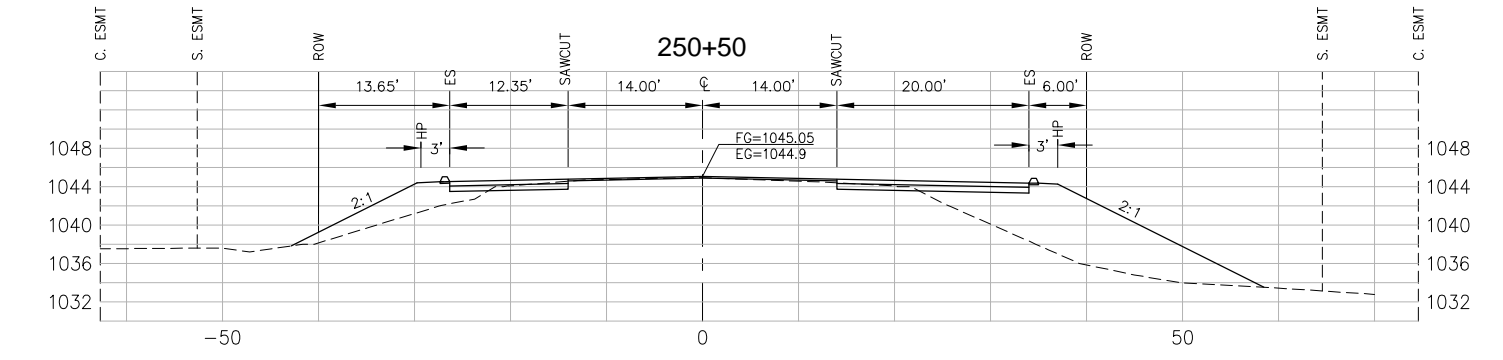
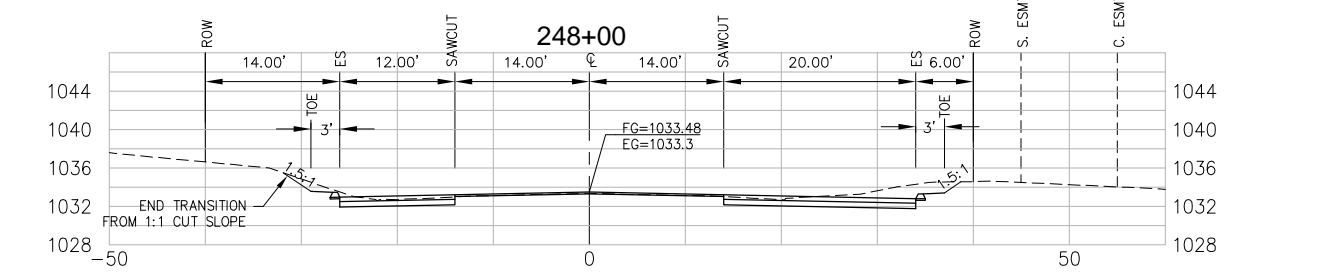
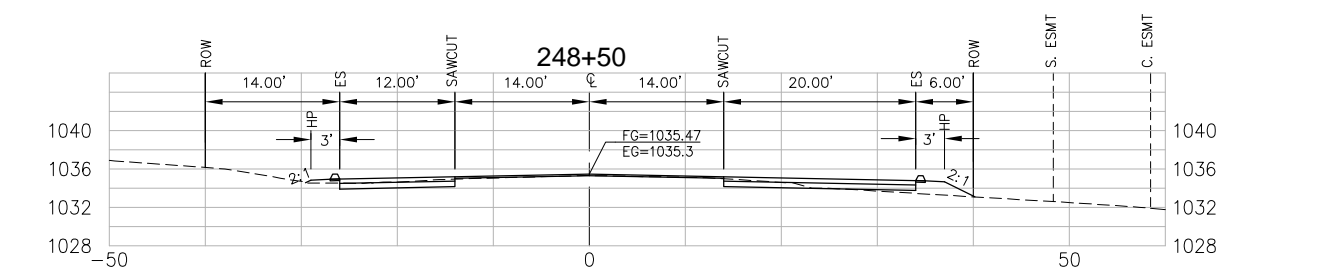
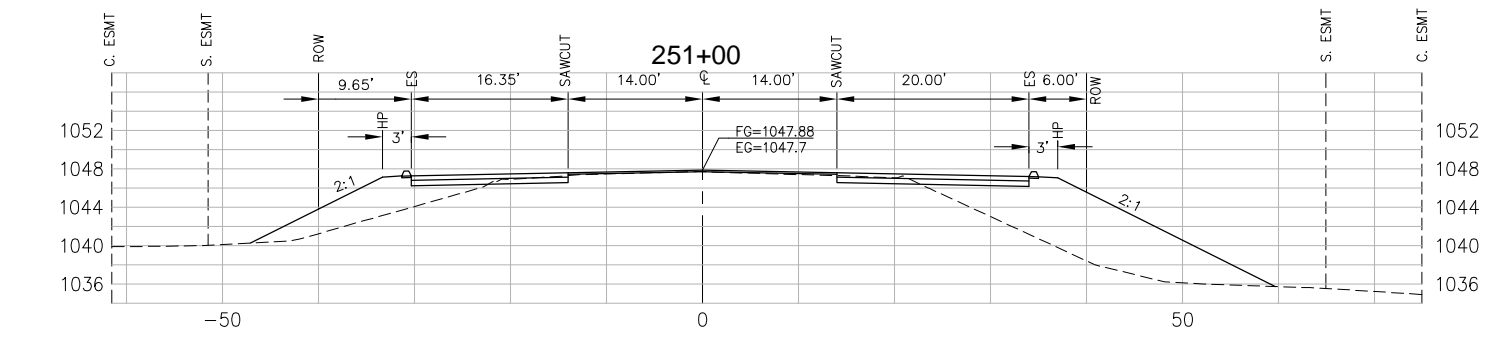
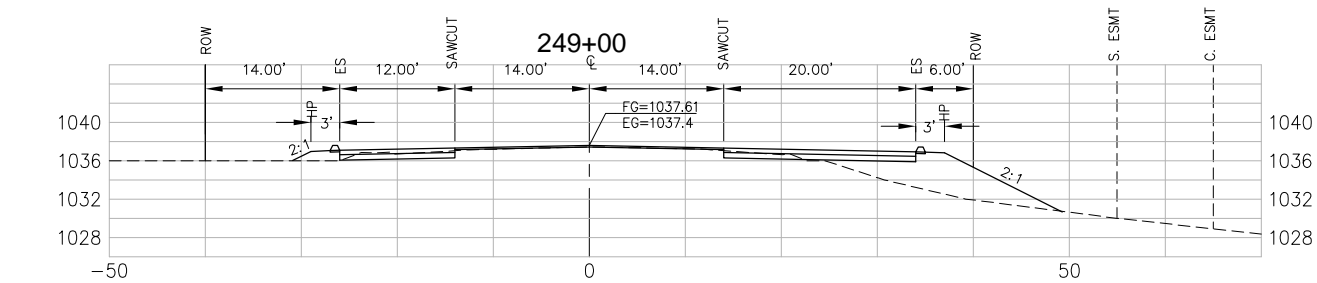
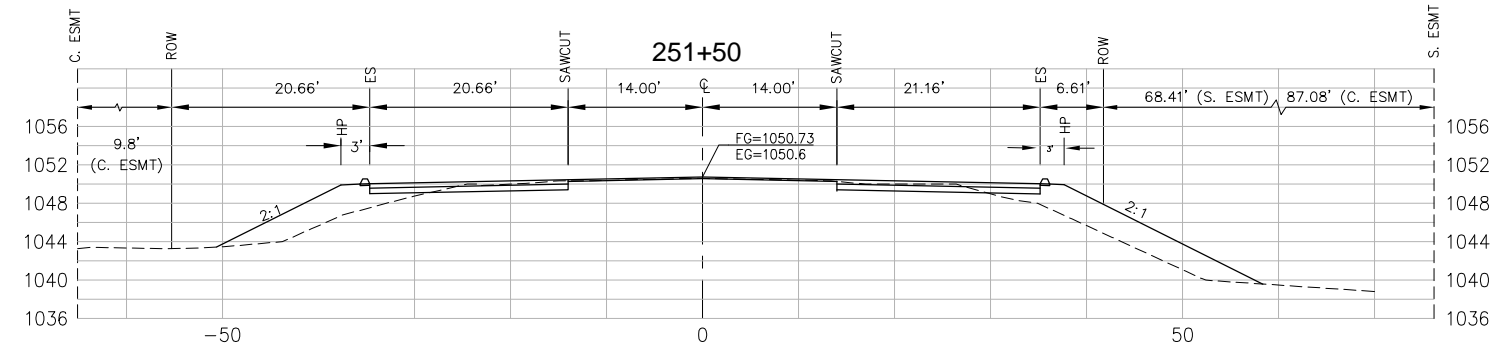
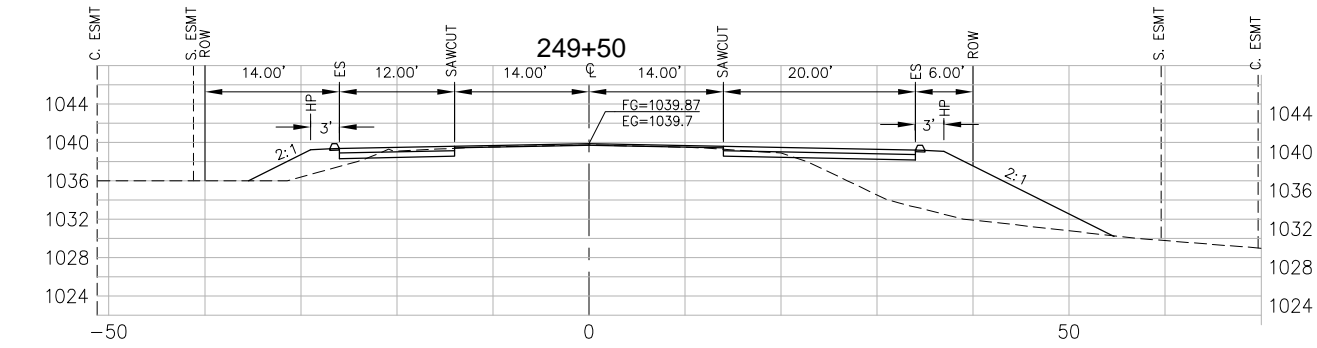
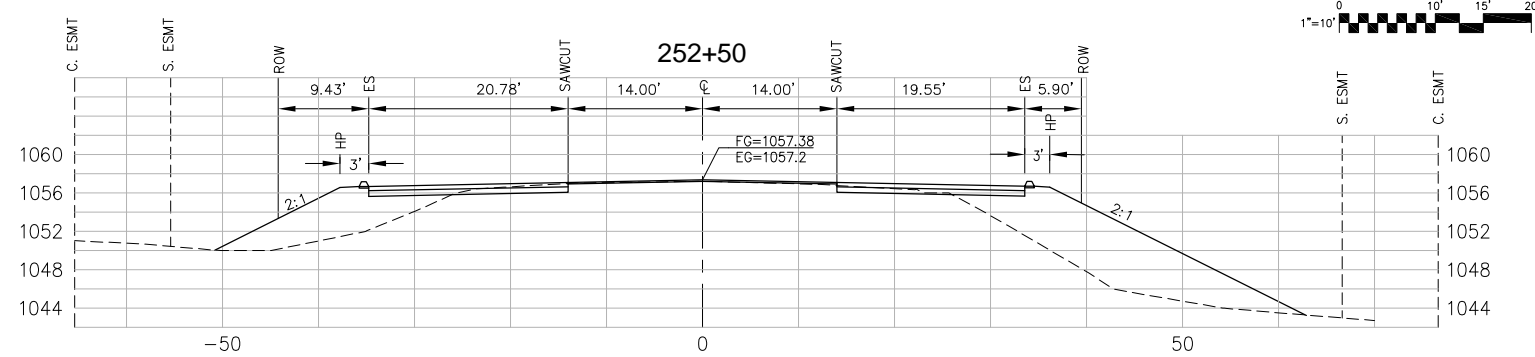
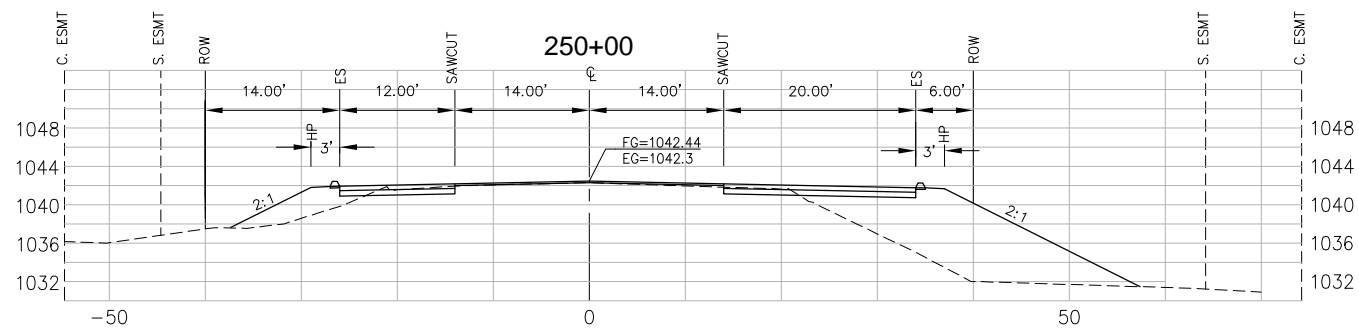

OWNER INFORMATION	SILVER SPRINGS LLC 2999 OAK ROAD, SUITE 400 WALNUT CREEK, CA 94597 (925) 933-1405
ENGINEERING & PLANNING	TLA ENGINEERING & PLANNING 1000 PARKWAY ROAD, SUITE 100 CALIFORNIA
PROJECT #66114	GREEN VALLEY ROAD/DEER VALLEY ROAD TURN LANES CROSS SECTIONS - GREEN VALLEY ROAD
DATE	TM 97-1330, COUNTY CONTRACT NO. PW 09-30470
REVISION	
APPROVED BY	
DATE	

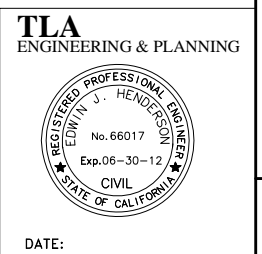

DATE:

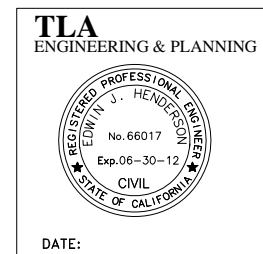
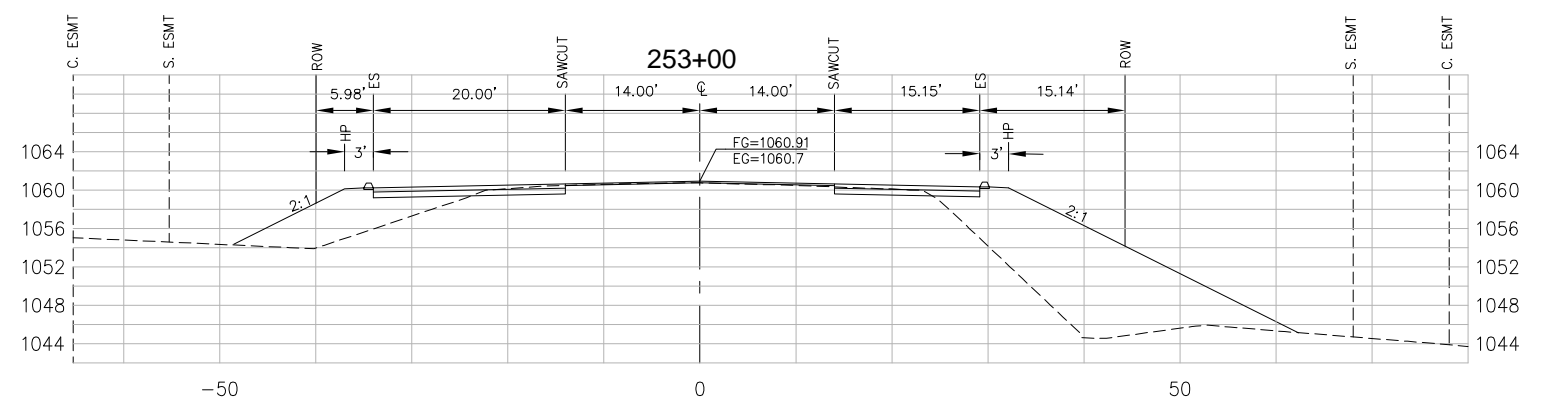
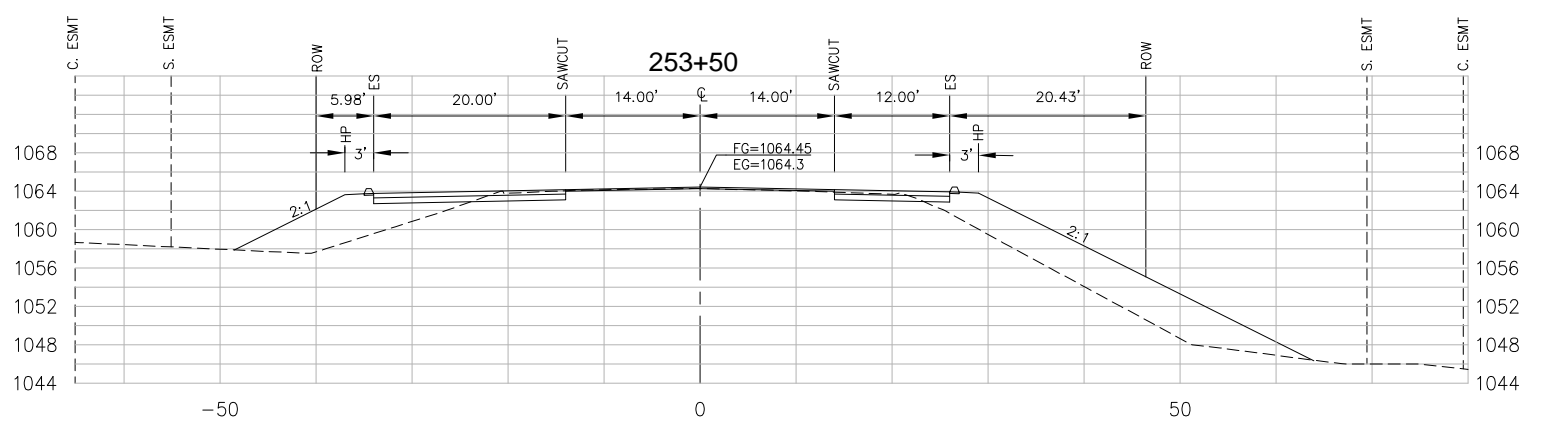
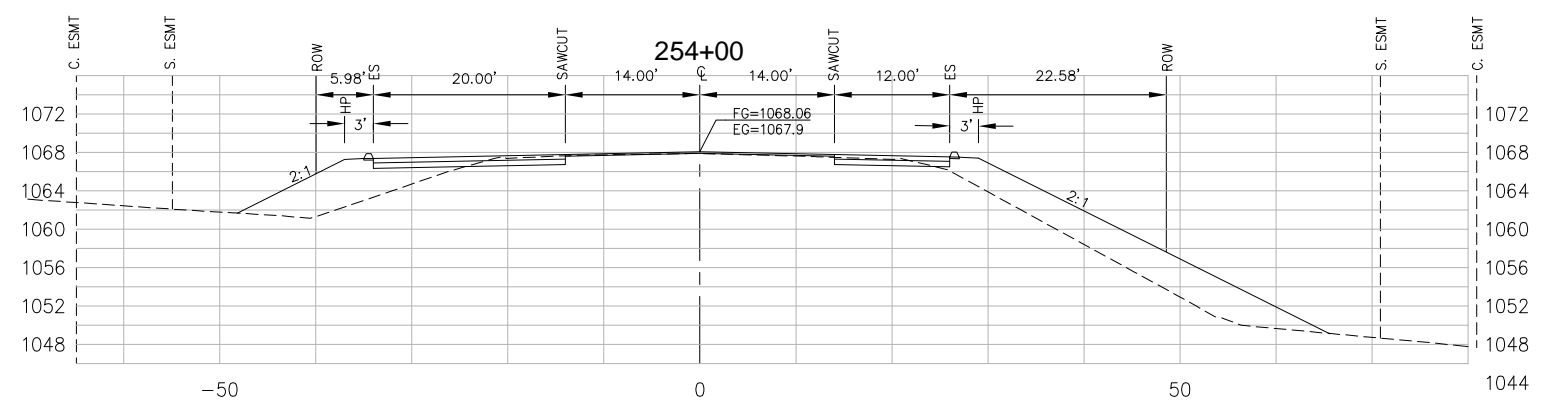
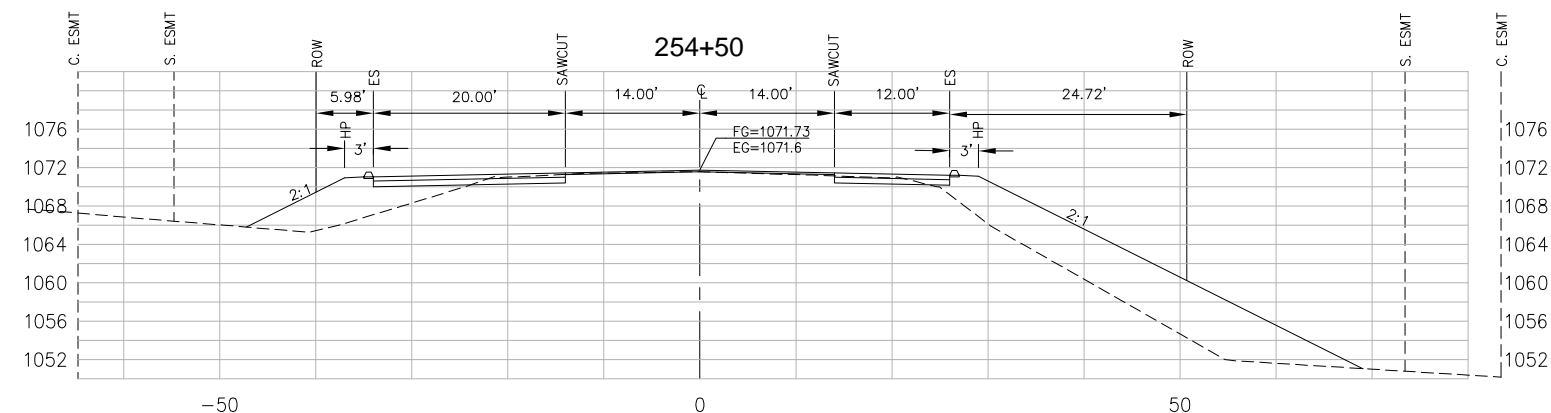

SHEET	3	3 OF 6	EL DORADO COUNTY	TM 97-1330, COUNTY CONTRACT NO. PW 09-30470	CALIFORNIA	GREEN VALLEY ROAD/DEER VALLEY ROAD TURN LANES CROSS SECTIONS - GREEN VALLEY ROAD	PROJECT #66114 GRADING AND IMPROVEMENT PLANS FOR	 ENGINEERING & PLANNING 2999 OAK ROAD, SUITE 400 WALNUT CREEK, CA 94597 (925) 933-1405	OWNER INFORMATION
									SILVER SPRINGS LLC. 2999 OAK ROAD, SUITE 400 WALNUT CREEK, CA 94597 (925) 933-1405
									REVISION
									APPROVED BY
									DATE

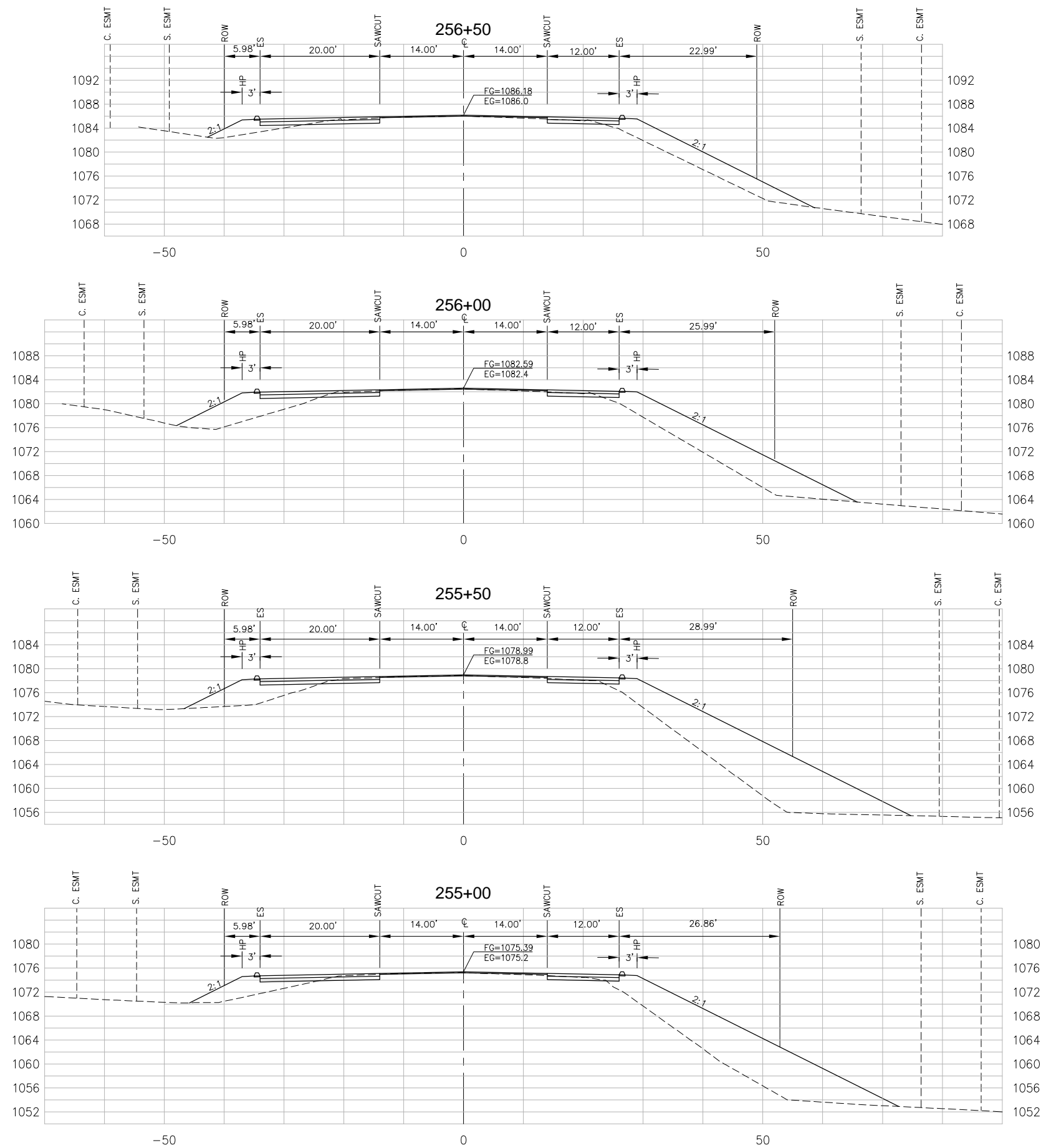

NO.	REVISION	DATE

OWNER INFORMATION
 SILVER SPRINGS LLC
 2999 OAK ROAD, SUITE 400
 WALNUT CREEK, CA 94597
 (925) 933-1405

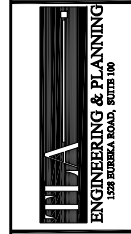

GRADING AND IMPROVEMENT PLANS FOR
PROJECT #66114
GREEN VALLEY ROAD/DEER VALLEY ROAD TURN LANES
 CROSS SECTIONS - GREEN VALLEY ROAD
 EL DORADO COUNTY TM 97-1330, COUNTY CONTRACT NO. PW 09-30470
 CALIFORNIA

TLA
 ENGINEERING & PLANNING

PRELIMINARY
 For Discussion Purposes Only

CIVIL
 STATE OF CALIFORNIA

DATE:

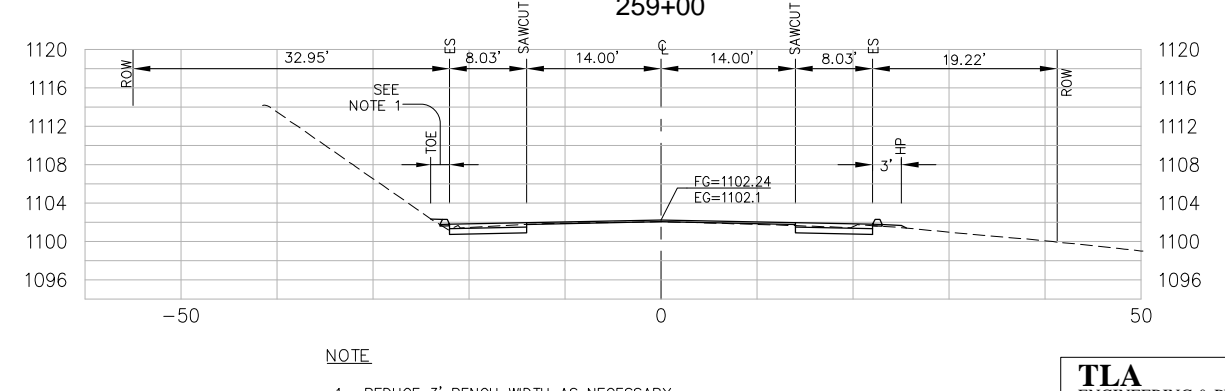
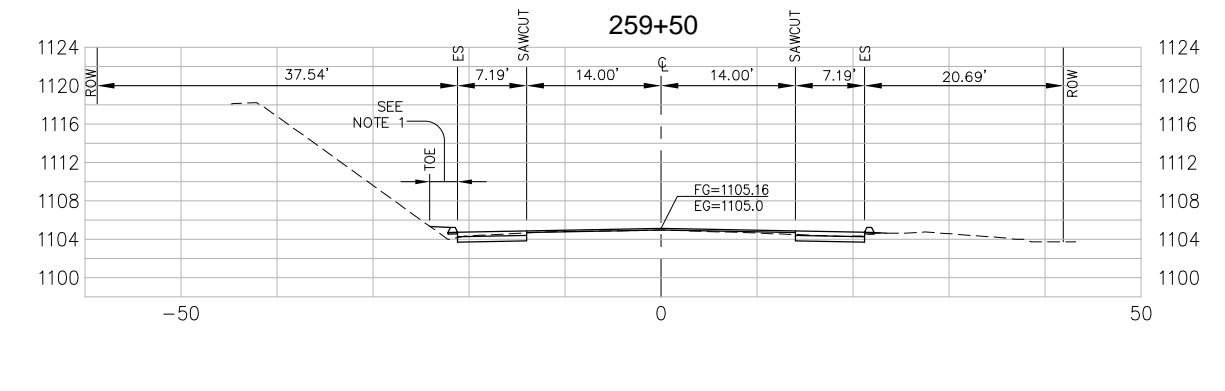
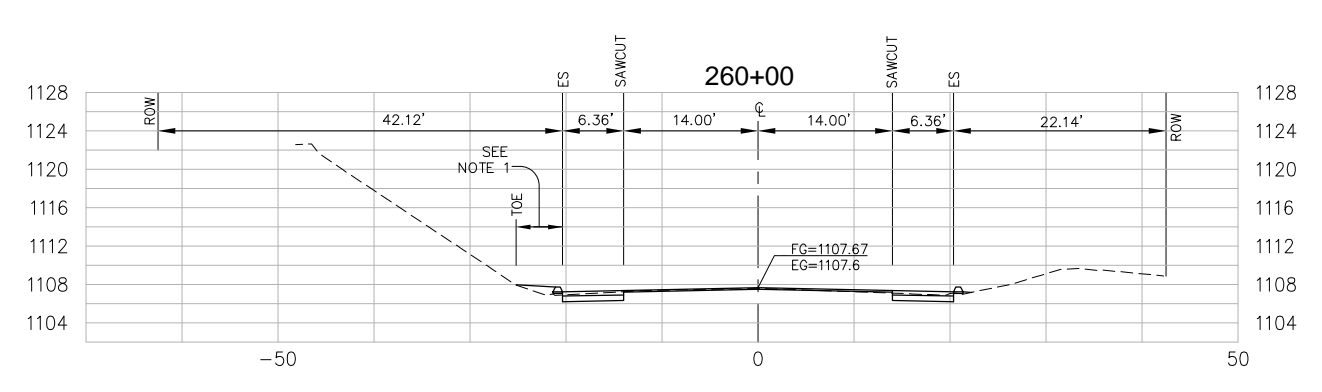
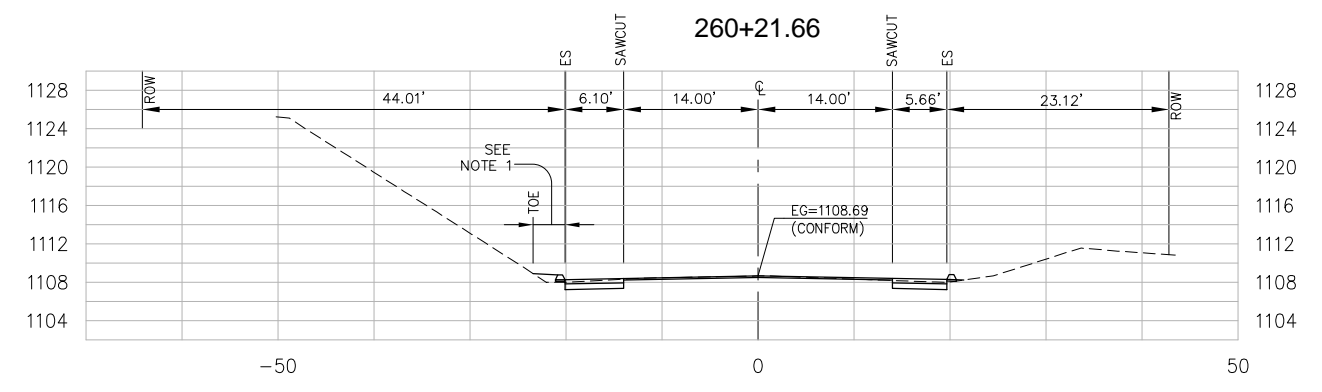
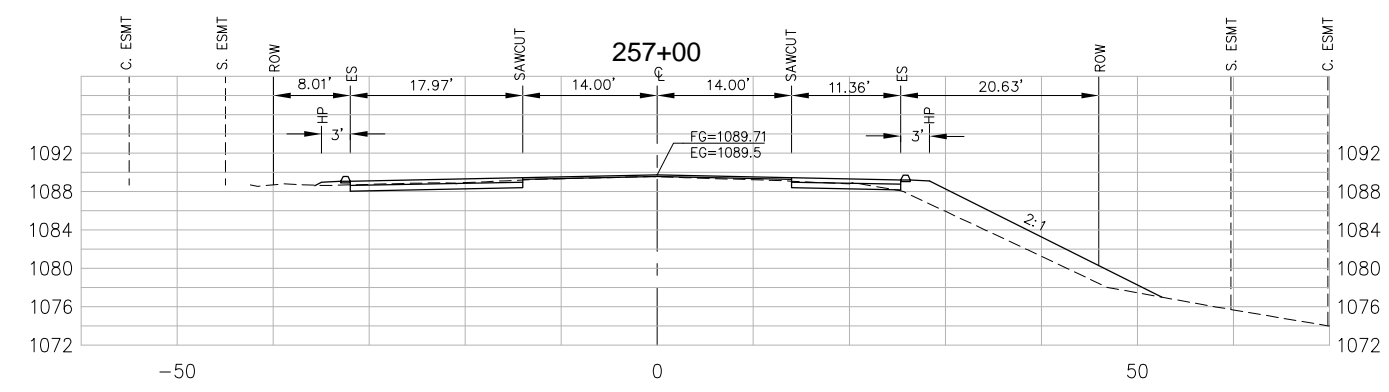
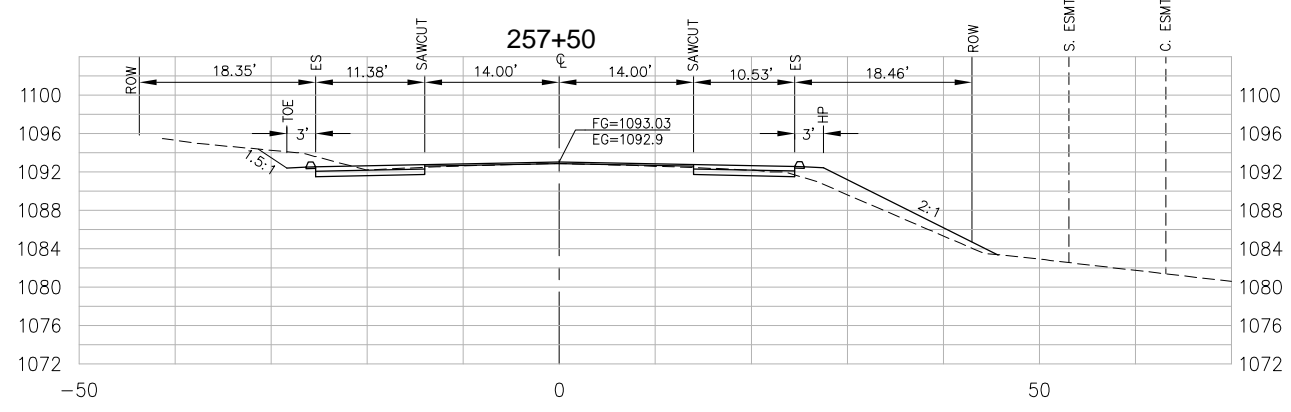
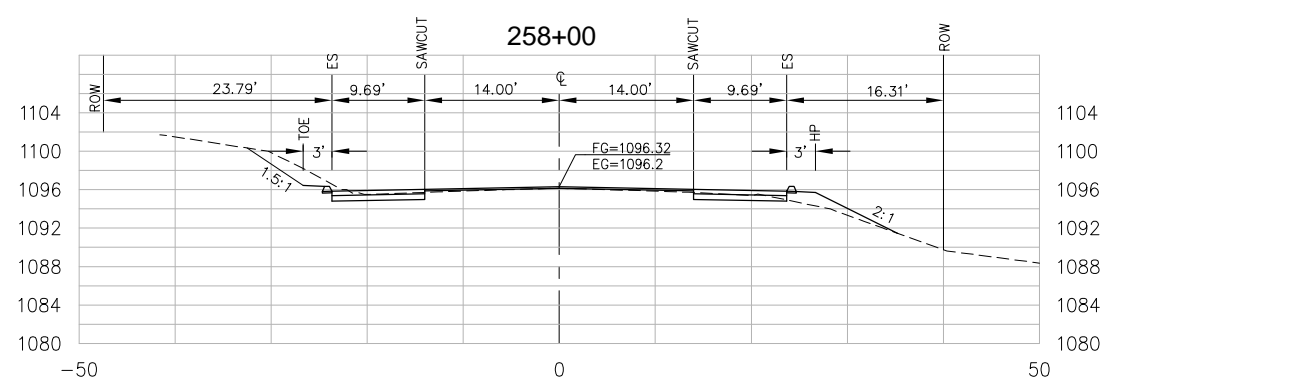
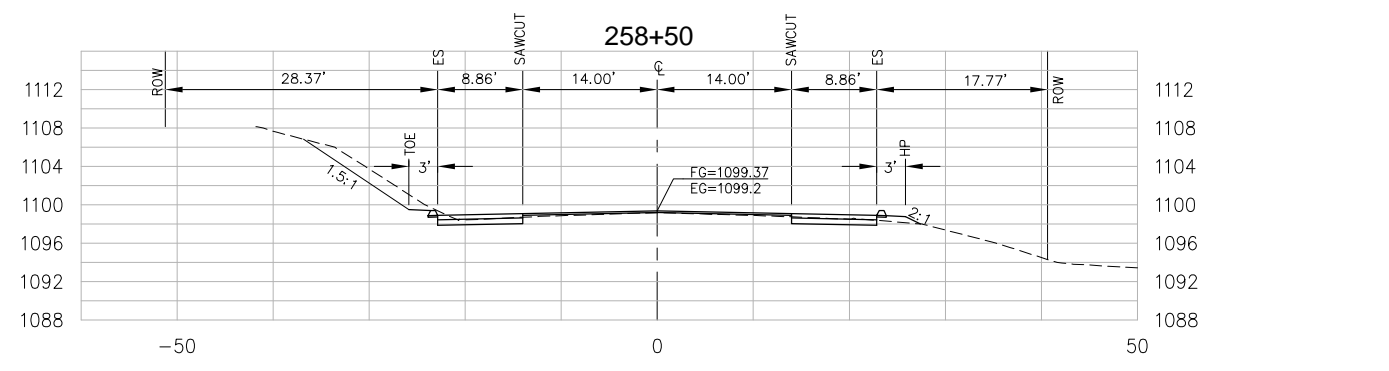
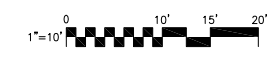

NOTE
 1. REDUCE 3' BENCH WIDTH AS NECESSARY FROM STATION 258+75 TO 260+21.66 TO AVOID CUTTING EXISTING SLOPE.

TLA
 ENGINEERING & PLANNING

DATE:

OWNER INFORMATION	SILVER SPRINGS LLC 2999 OAK ROAD, SUITE 400 WALNUT CREEK, CA 94597 (925) 933-1405
ENGINEERING & PLANNING	1000 PARKWAY SUITE 100 DUBLIN, CA 94568
PROJECT #66114	GREEN VALLEY ROAD/DEER VALLEY ROAD TURN LANES
CROSS SECTIONS - GREEN VALLEY ROAD	
TM 97-1330, COUNTY CONTRACT NO. PW 09-30470	CALIFORNIA
EL DORADO COUNTY	
SHEET	5
5 OF 6	

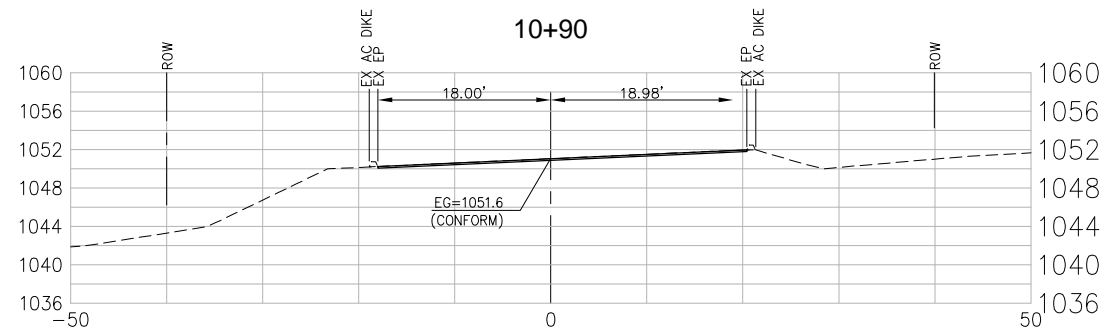
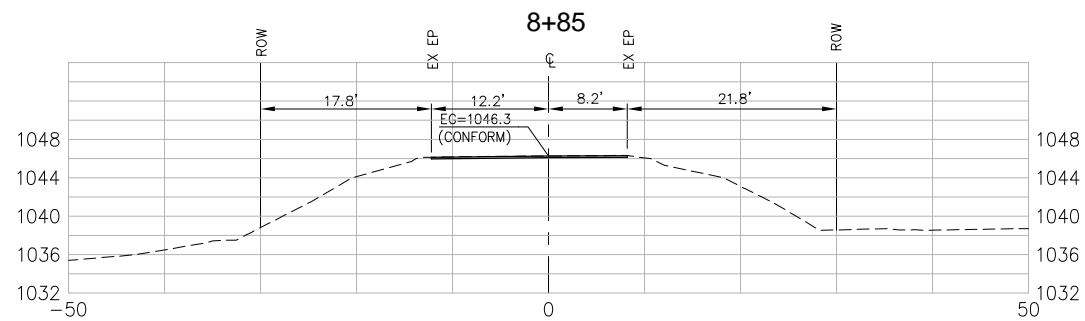
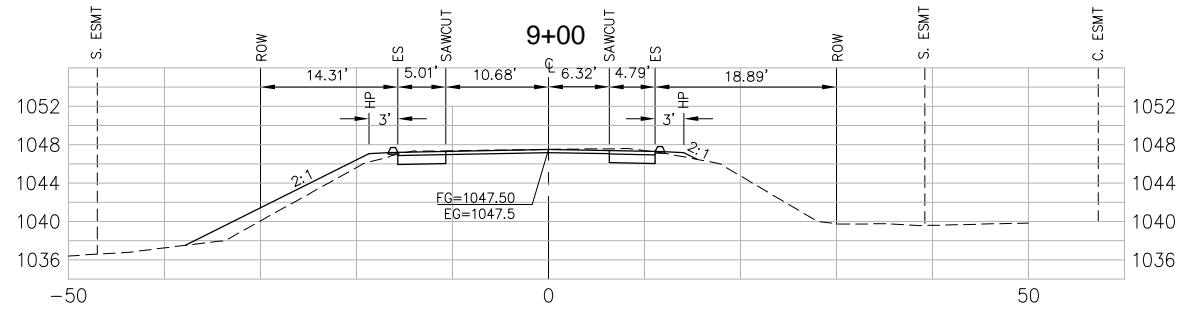
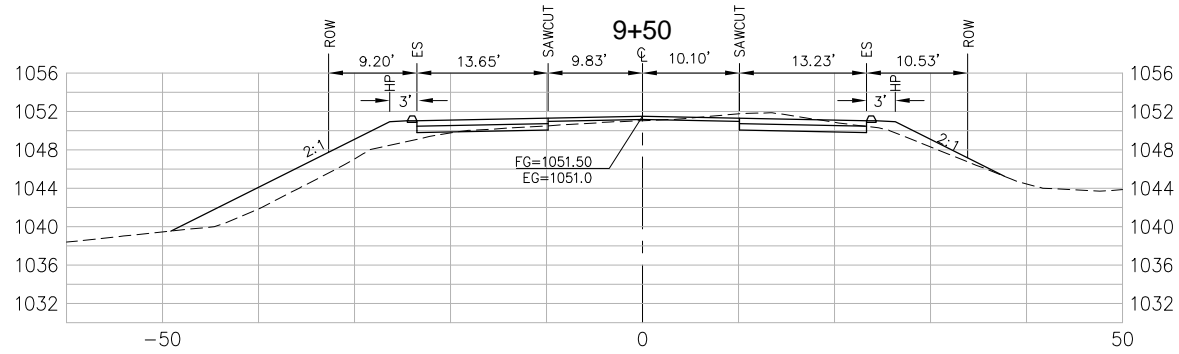
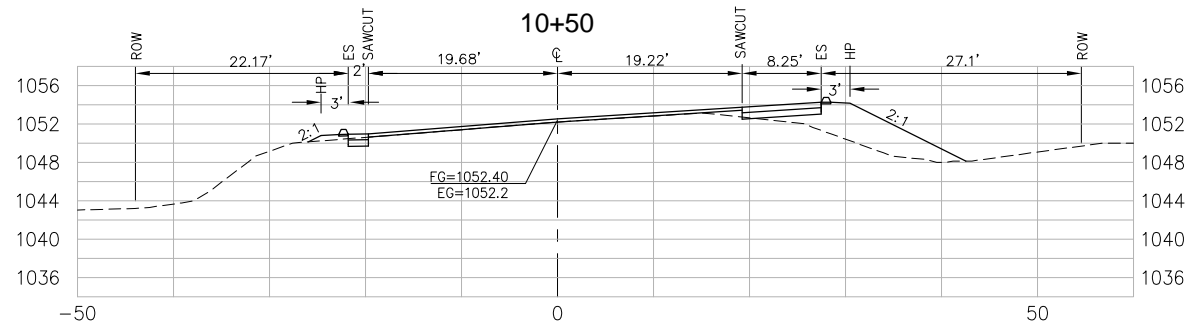

NO.	REVISION	DATE

OWNER INFORMATION
 SILVER SPRINGS LLC
 2999 OAK ROAD, SUITE 400
 WALNUT CREEK, CA 94597
 (925) 933-1405



GRADING AND IMPROVEMENT PLANS FOR
PROJECT #66114
GREEN VALLEY ROAD/DEER VALLEY ROAD TURN LANES
 CROSS SECTIONS - DEER VALLEY ROAD
 EL DORADO COUNTY TM 97-1330, COUNTY CONTRACT NO. PW 09-30470
 CALIFORNIA

TLA
ENGINEERING & PLANNING

DATE: