



COUNTY OF EL DORADO
DEPARTMENT OF TRANSPORTATION

Henningesen Lotus Class 1 Trail

PUBLIC MEETING



April 8, 2026



AGENDA

→ Welcome / Introductions

Henningsen Lotus

→ Henningsen/ Lotus Rd Class 1

Trail Project Overview

→ Project Updates & Look Ahead

QUESTIONS & DISCUSSION

→ Open Discussion





Project Updates

Project Opportunities

- Extending connectivity with current and future projects
- EDCTC, County, State Parks, Caltrans and SACOG partnering opportunities

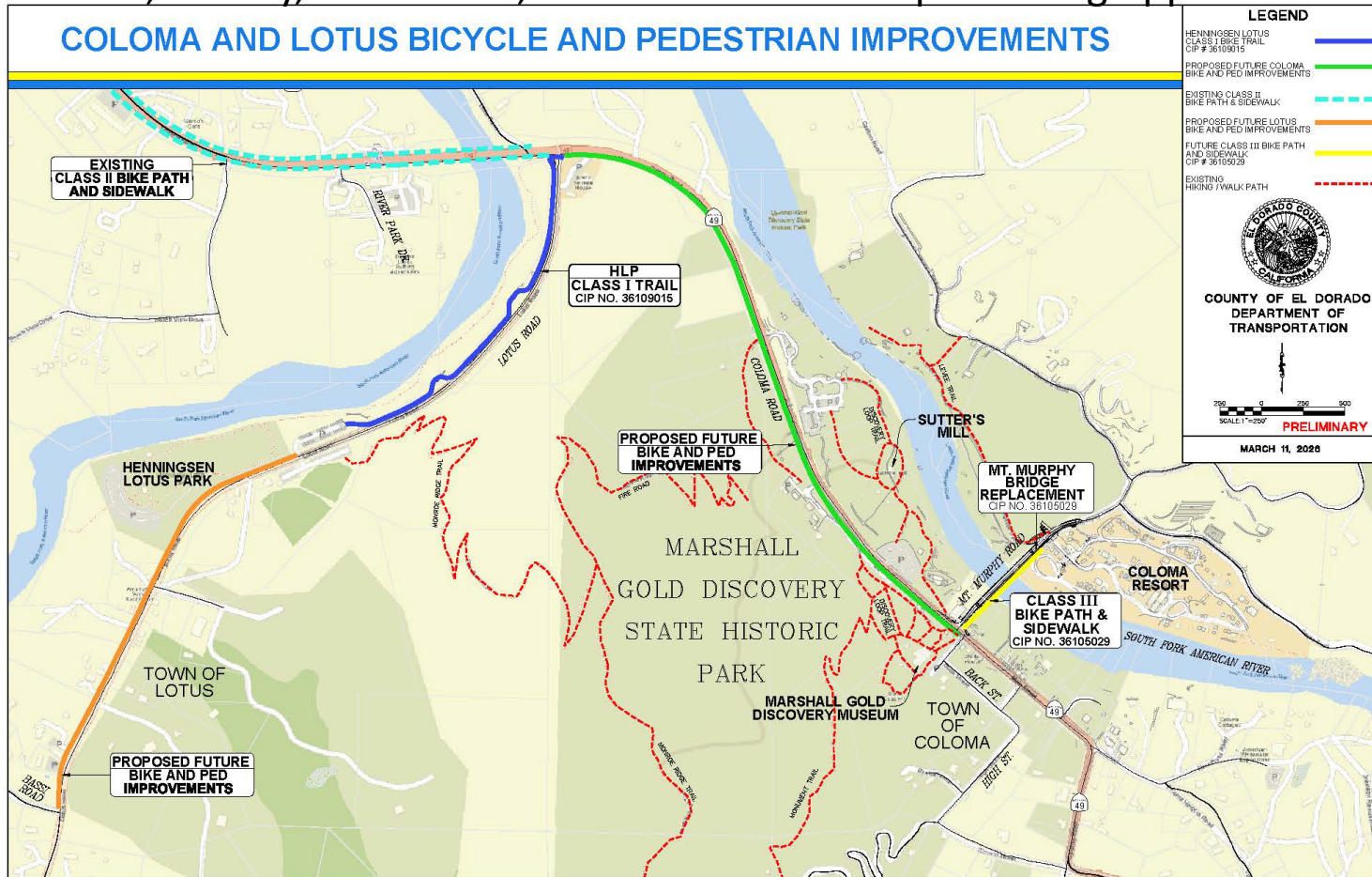



**COUNTY OF EL DORADO
DEPARTMENT OF TRANSPORTATION**

Henningsen / Lotus Multi-Use Trail
Class 1 Trail from Henningsen Lotus Park to SR 49

PROJECT UPDATE

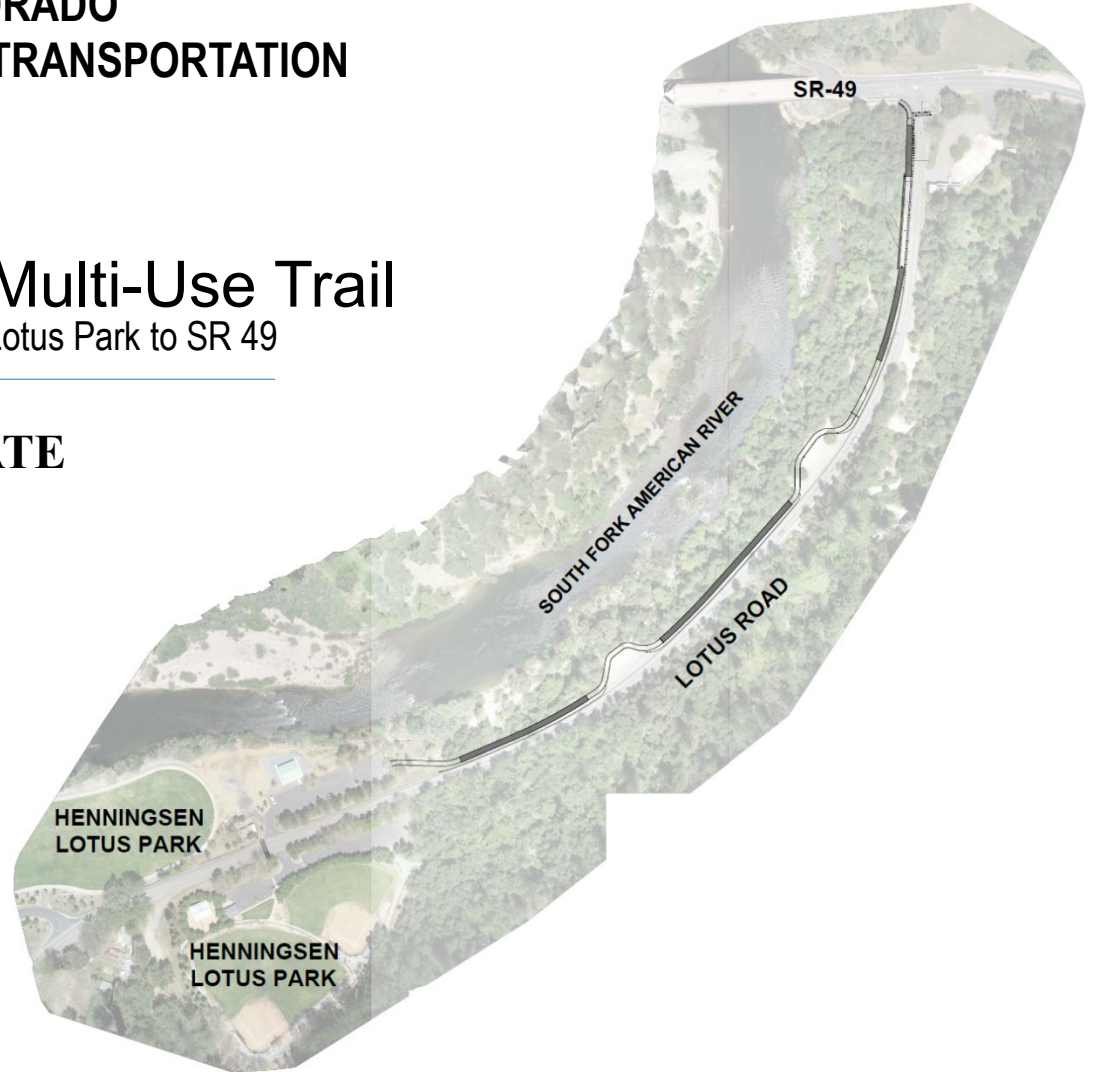

Public Meeting

April 8, 2026



Project History (Recap):

- Henningsen Lotus Conceptual Master Plan – June 2014
- Coloma Sustainable Community Mobility Plan – October 2019
- Active Transportation Plan – February 2020
- Henningsen/ Lotus Road Class I Multi-Use Trail
 - CMAQ Grant (2022) for Planning/Design/ROW
 - CIP Project 2024/2025
 - Public Outreach: May 2022, April 2023, June 2023, November 2023, January 2024, March 2025, June 2025, August 2025
 - CEQA/ NEPA Clearance – June 2025

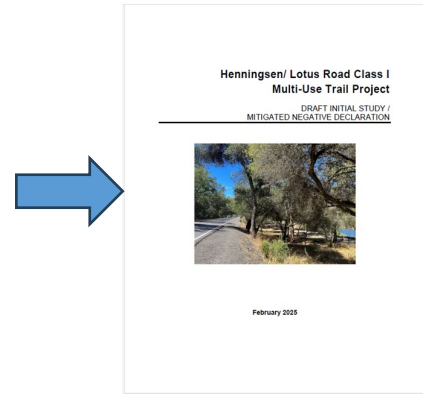
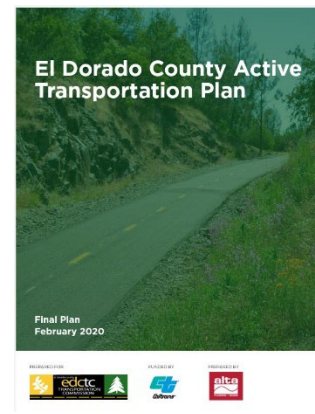
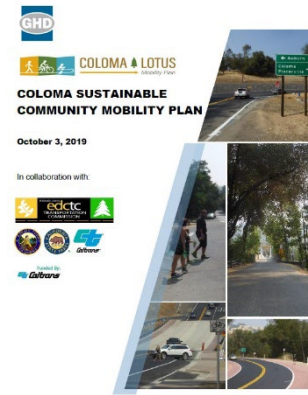
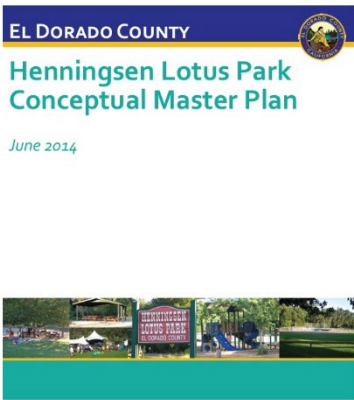
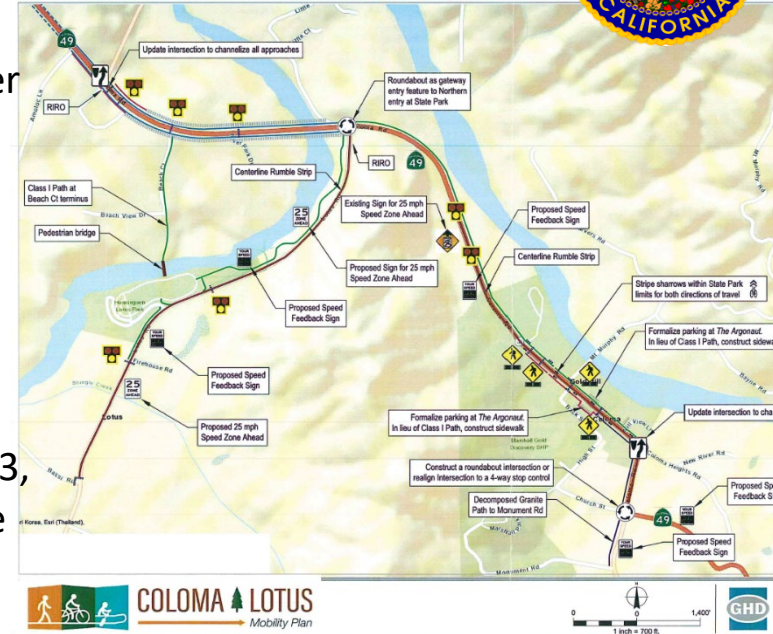



Project Overview:

↳ Project Goals:

- ↳ Connectivity between Henningsen Lotus Park and SR 49 Approx. 2,300 LF
- ↳ Class I Multi-Use Trail (safely accommodate multiple user needs)
- ↳ Tie into natural trails, park, SR49 sidewalk/bike lane
- ↳ Accommodate Bicycles, Pedestrians, etc.
- ↳ Minimize Impacts To Surrounding Resources

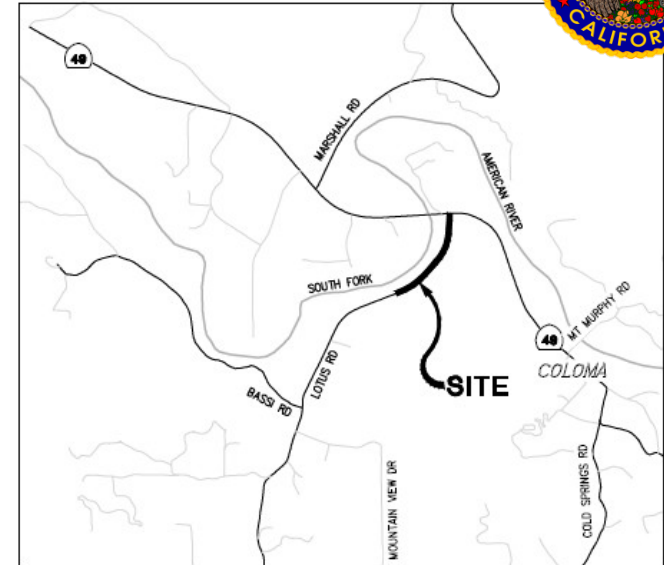



Project History & Alternatives:

- ↳ Class I Multi-Use Trail (Near Lotus Road)
 - ↳ Coincides with Existing Facilities (Ties into nature trails, parking areas, bicycle user needs, pedestrian needs)
 - ↳ Minimizes Environmental Impacts
 - ↳ Above Flood Plain/High Water
 - ↳ Utilizes County Right-of-Way (No new ROW)
 - ↳ Consistent Prior Studies
 - ↳ Grant Funding Potential

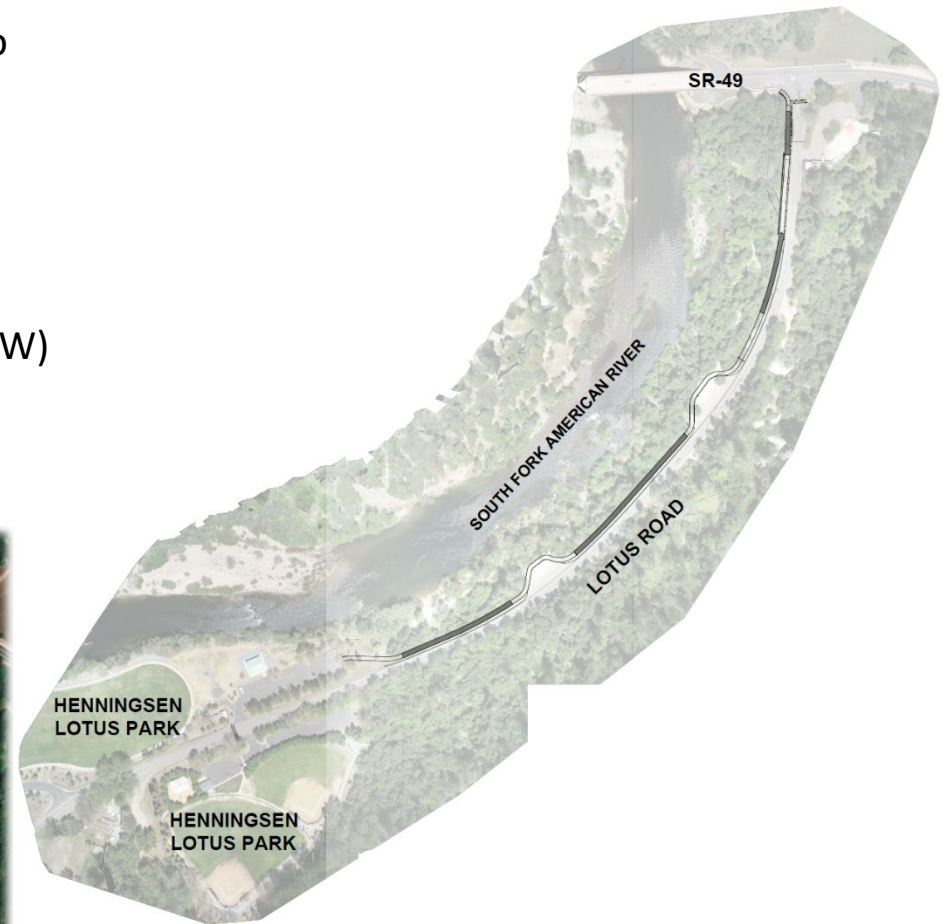



Project Update

Extensive Coordinated Efforts

- County Of El Dorado, Parks Department, State Parks, Caltrans, Tribes, Public, etc.
- Opportunities to Integrate with Existing Features, Projects, and Needs (Future Caltrans Project, etc.)

- EXISTING CLASS II BIKE LANE
- EXISTING SIDEWALK
- PROPOSED CLASS 1 TRAIL

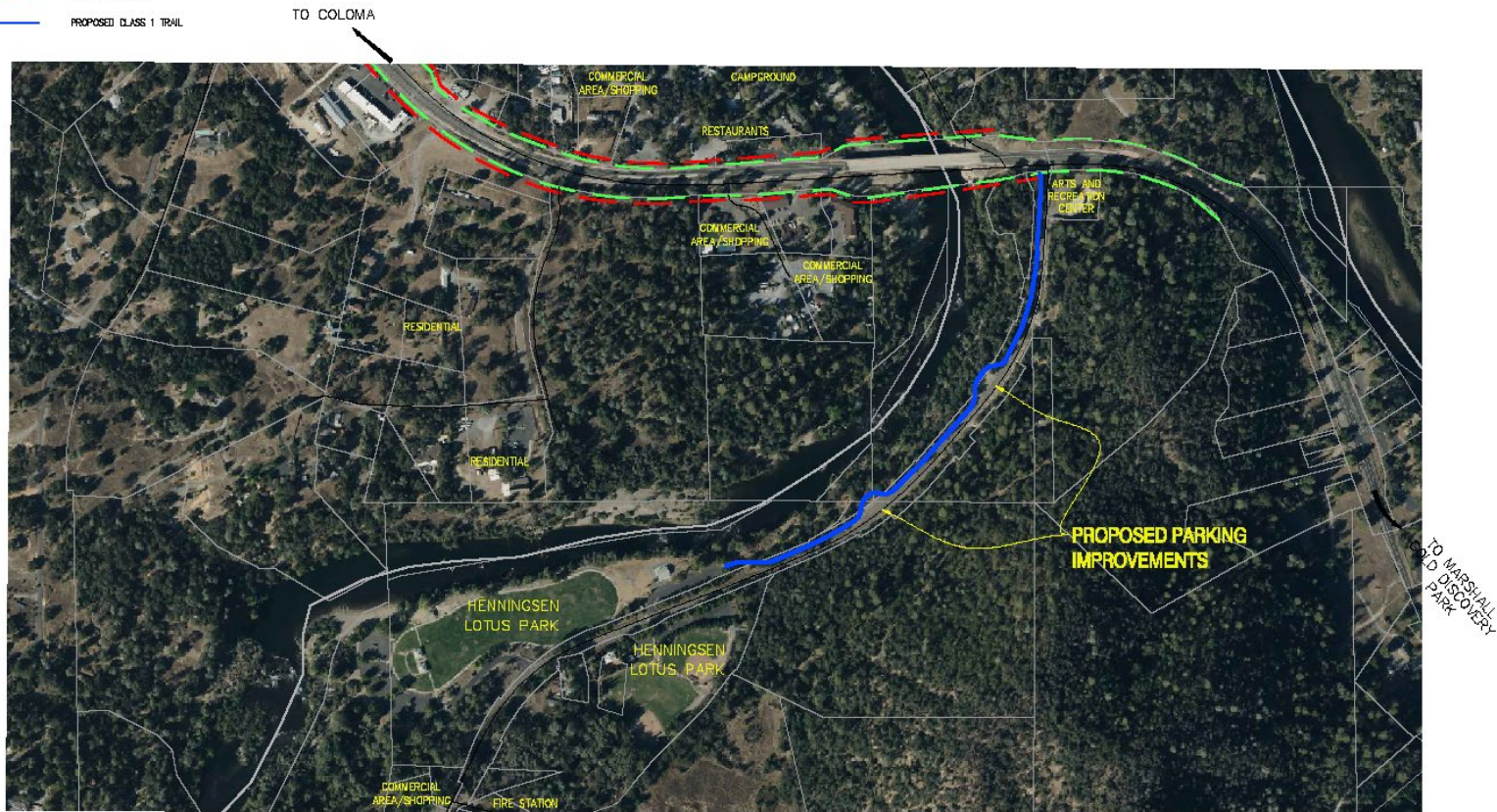



Project Update

Design Features

- ➔ **Integrate with Connectivity and Existing Facilities**
 - ➔ Connects SR49 improvements with Henningsen Lotus Park
 - ➔ Improves Safety and Connectivity of 2 roadside Parking lot Areas
 - ➔ Preserves existing trail connections at Parking Areas
 - ➔ Crosswalk improvements Lotus/SR49
 - ➔ Does not preclude future nature trail projects

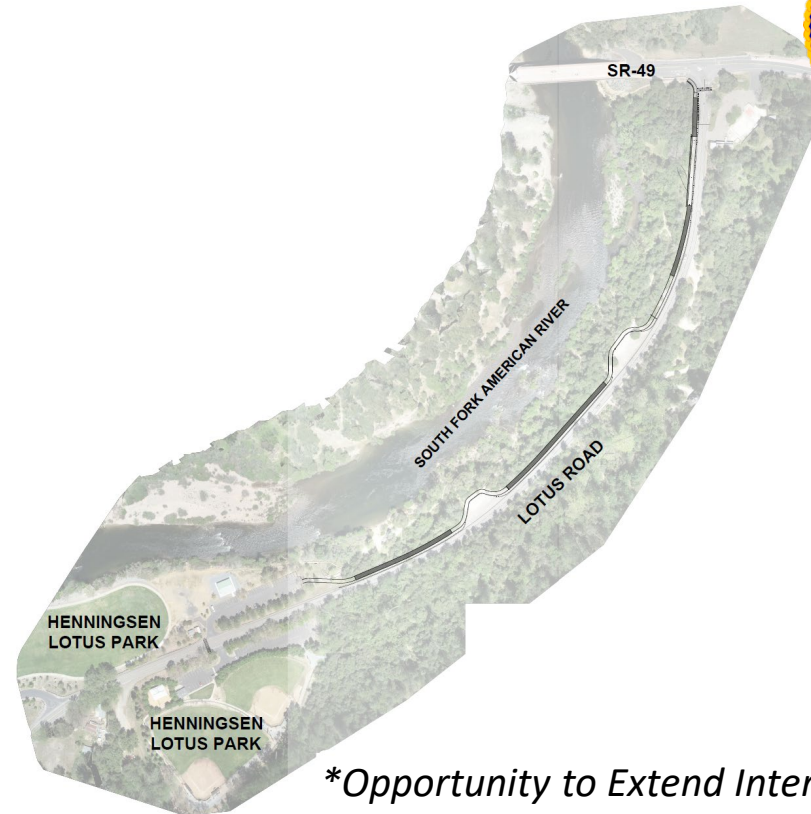

**Opportunity to Extend Interpretative Program (State Parks & Tribe)*

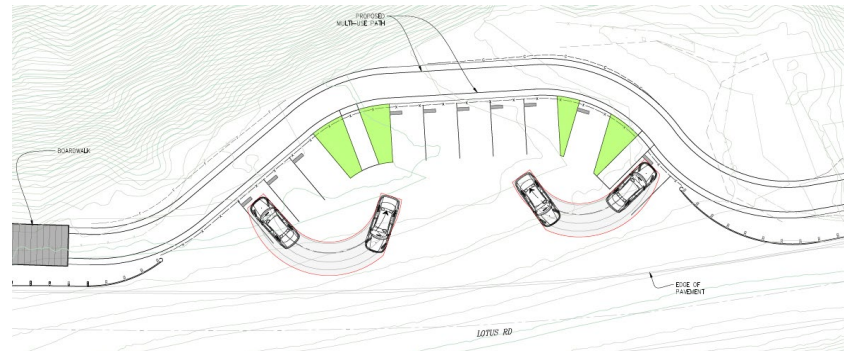



Project Update

Design Features

- ➔ Opportunities to Expand the Interpretive Program
 - ➔ Coordinated Efforts (Tribe & State Parks) - Overview

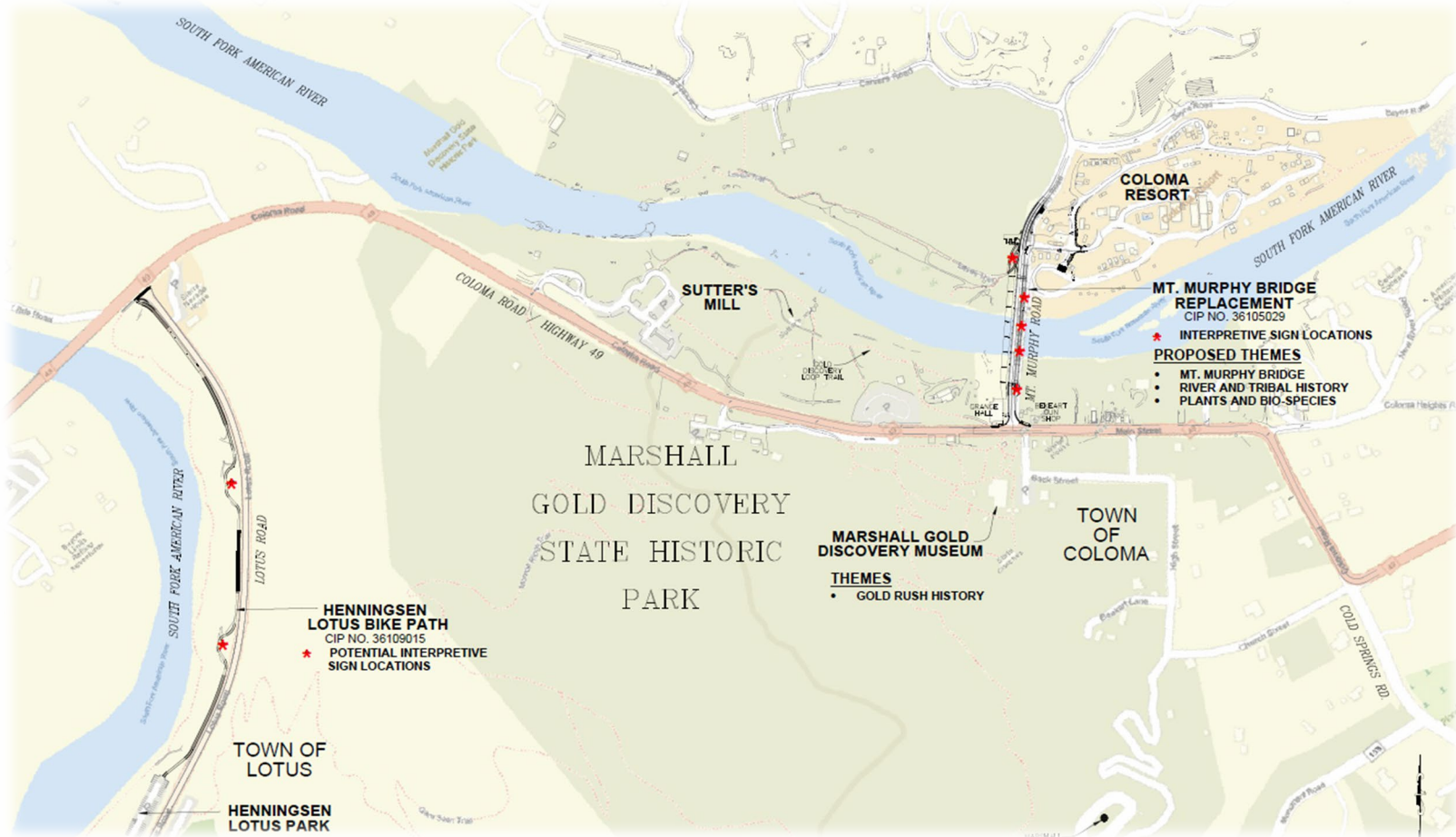



Project Update

Design Features

➔ Opportunities to Expand the Interpretive Program

➔ Panel Examples





Project Update

Design Features

→ Elevated Boardwalk

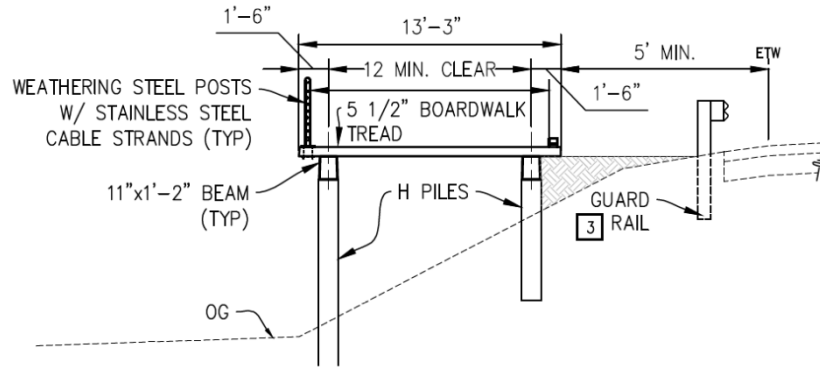



Project Update

Design Features

- ↳ Elevated Boardwalk
 - ↳ Geotechnical Exploration (Updates)



Photo 1: Segment of proposed boardwalk at approximately STA 28+00, looking northeast.

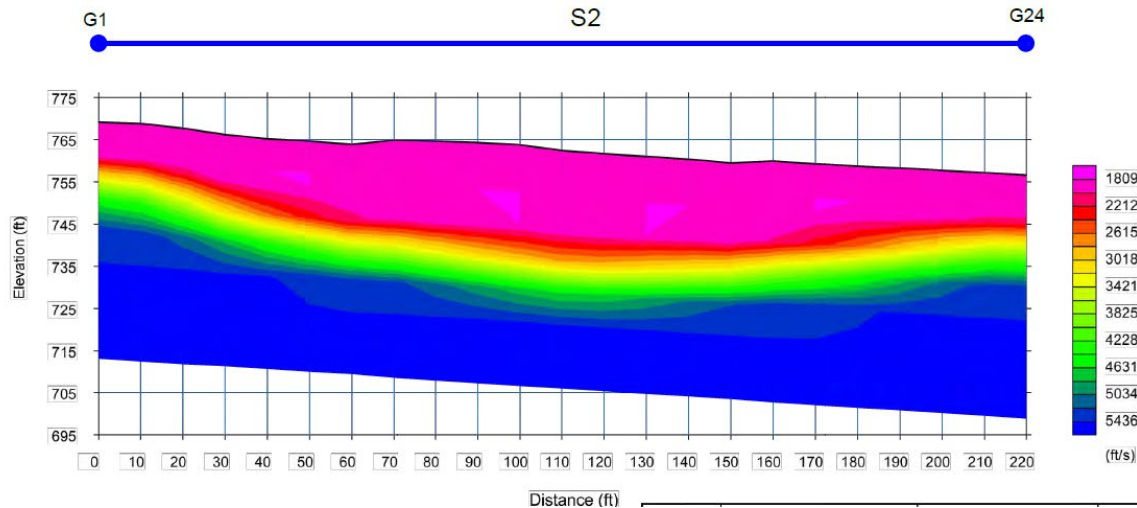
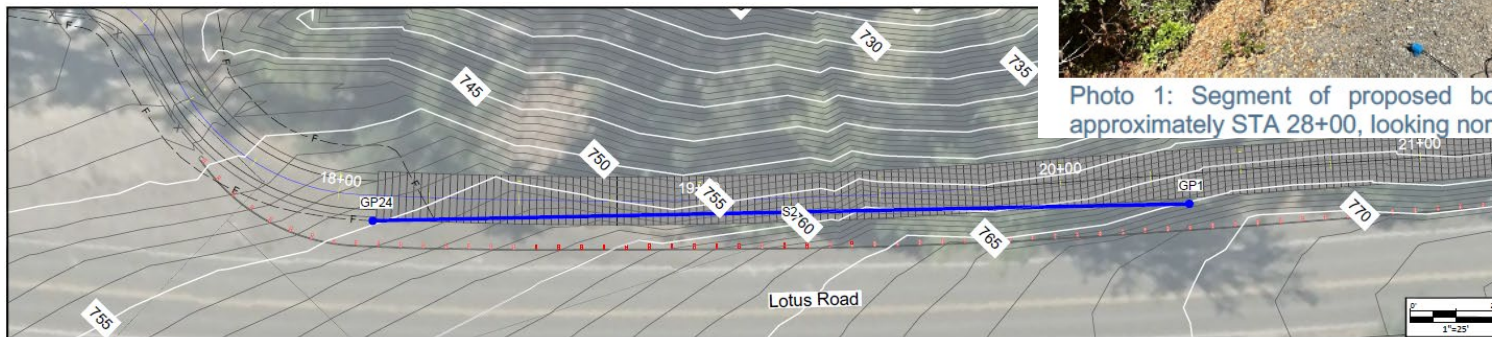



Project “Look Ahead”

- ↳ Anticipated Schedule

Overview Schedule:



- ↳ **Planning & Design** – 2023 thru 2026
 - ↳ (includes: CEQA/ NEPA clearances, Geotechnical Exploration, Structural Evaluation, etc.)
- ↳ **Right of Way (ROW) Certification Caltrans** – 2026 No ROW-ROW Cert
- ↳ **Construction** – 2027/2028 (Pending Funding/ *Grant Opportunities)
- ↳ **Scope Future Phases-** *Partner with State to extend features to Marshall Gold Discovery Park. Study potential extension of features to Bassi Rd.



CONCLUDING REMARKS



El Dorado
COUNTY

Find almost anything on our website

Search

County Government | Land Use | Health & Well Being | Public Safety & Justice | Services

Home / Land Use / County Projects / Trail Projects / Henningsen/ Lotus Road Class I Multi-Use Trail Project

County Projects



In This Section

Bridge Projects

Pedestrian Crosswalk Improvement Projects

Road & Transportation Projects

Trail Projects

El Dorado Trail - Missouri Flat Road Bike/ Pedestrian Overcrossing

Henningsen/ Lotus Road Class I Multi-Use Trail Project

Henningsen/ Lotus Road Class I Multi-Use Trail Project

Welcome to the El Dorado County Henningsen/ Lotus Multi-Use Trail Project website.



What's New

NEW: [Take this Survey to provide valuable feedback regarding this Project](#)

[Project Update Presentation at the Parks and Recreation Commission Meeting on Thursday, August 21, 2025](#) - Posted 08/19/25

[Notice of Intent to Adopt a Mitigated Negative Declaration and Public Meeting Notice for March 13, 2025 at 6:00 pm](#) (PDF, 1MB)

[Initial Study/ Mitigated Negative Declaration Document](#) (PDF, 21MB)

You can also find these documents on our CEQA website: [CEQA - El Dorado County](#)

Updates & Presentations

- [Project Update Presentation at the Parks and Recreation Commission Meeting on Thursday, August 21, 2025](#) - Posted 08/19/25
- [Public Meeting Presentation at the Henningsen Lotus Park Pavilion](#) (PDF, 6MB) on March 13, 2025
- Town Hall Meeting presented by District IV Supervisor, Lori Parlin, DOT Director, Rafael Martinez, and EDCTC Executive Director, Woodrow Deloria on January 17, 2024 at the Gold Trail Grange: [Video link](#)
- [Public Meeting with the Coloma Lotus Advisory Committee](#) on November 2, 2023
- PowerPoint Slides from the November 2, 2023 Meeting - Posted 11/03/2023
- [Public Meeting with the Parks and Recreation Commission](#) on June 15, 2023
- Public Meeting with the Coloma Lotus Advisory Committee on April 6, 2023: This project was discussed during item #2 on the agenda.
- Town Hall Meeting on May 12, 2022: PowerPoint Slides from this meeting

<https://www.eldoradocounty.ca.gov/Land-Use/County-Projects/Trail-Projects/Henningsen-Lotus-Road-Class-I-Multi-Use-Trail-Project>



**COUNTY OF EL DORADO
DEPARTMENT OF TRANSPORTATION**

Questions & Open Discussion



Public Meeting

April 8, 2026



COUNTY OF EL DORADO
DEPARTMENT OF TRANSPORTATION

We invite you to take the County's survey on the
Henningsen/ Lotus Road Trail Project:



Public Meeting

April 8, 2026